

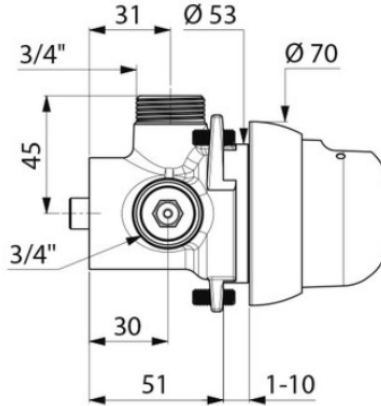







PROJECT		REF		REV	ITEM CODE	
LOCATION		DATE			PAGE	

SANITARY WARE SPECIFICATION SHEET

<p>Item Descriptions</p> <p>Model</p> <p>Material/ Finish</p> <p>Manufacturer</p> <p>Source</p> <p>Contact Tel/Fax</p> <p>E-mail</p> <p>Website</p>	<p>Delabie (France) "TEMPMATIC" Chrome plated concealed shower mixer</p> <p>790970</p> <p>Chrome Plated</p> <p>Delabie (France)</p> <p>Acme Sanitary Ware Co. Ltd Mr. Eric Wong/ Mr. Don Yuen</p> <p>(852) 2388-7171 / (852) 2710-8012</p> <p>acme@acmesanitary.com.hk</p> <p>www.acmesanitary.com.hk</p>	<p>Illustration/ Drawing</p>   <p>Time flow system tested to over 500000 operations</p> <p>Soft-touch operation</p>
<p>Description</p> <p>TEMPOMIX shower mixer</p> <p>Ref. 790970</p> <p>Exposed time flow shower mixer:</p> <p>TEMPOMIX 3/4" single control mixer.</p> <p>For panels 1 - 10mm.</p> <p>Temperature control and operation via the push-button.</p> <p>Maximum temperature limiter (can be adjusted by the installer).</p> <p>Soft-touch operation.</p> <p>Time flow ~30 seconds.</p> <p>Flow rate 12 lpm at 3 bar, can be adjusted.</p> <p>Chrome-plated solid brass.</p> <p>Integrated non-return valves and filters.</p> <p>Chrome-plated metal push-button.</p> <p>Connector 3/4"</p> <p>Technology Time flow</p> <p>Flow rate 12 lpm</p> <p>Standards and certifications     </p>		

Note:

* All information of the above is for the reference only. No prior notice is made if any changes.



PROJECT		REF		REV	ITEM CODE	
LOCATION		DATE			PAGE	

SANITARY WARE SPECIFICATION SHEET

Réf. 790970

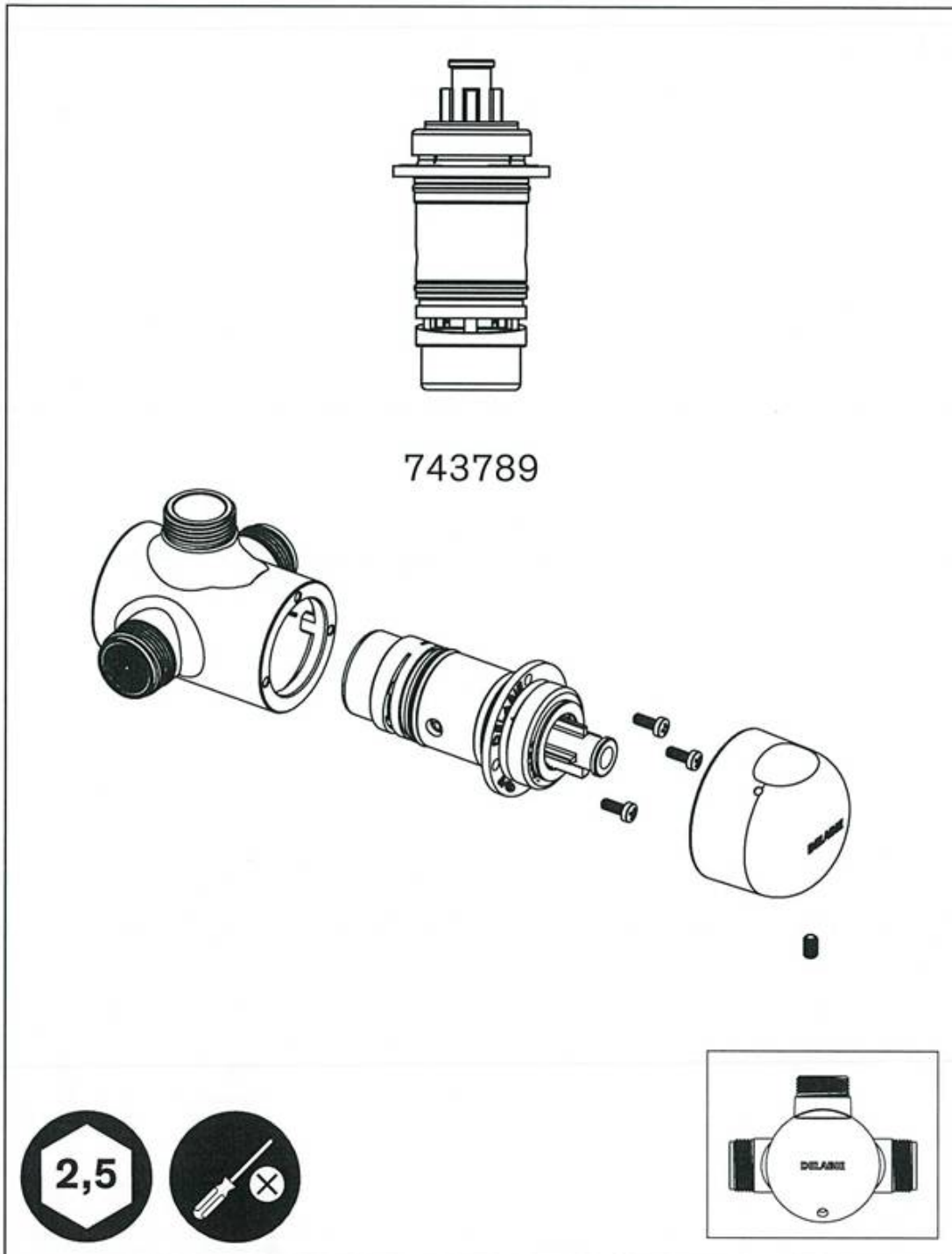



入境事務大樓48樓七號道
48/F, Immigration Tower, 7 Gloucester Road, Wan Chai, Hong Kong

本署檔號 : (4) in WSD 3321/2020 T/J(147/2020)
Our ref.
來函檔號 :
Your ref.

電話 :
Tel.
傳真 : 2824 0578
Fax.

20 April 2020

Approval of "DELABIE" Self Closing Mixer (General Acceptance No. C20200262)

Your letters both ref. 790970 dated 20 February 2020 and 20 March 2020 refer.

Having considered the test report ref. J23773r3 issued on 9 January 2020 by Nutek Systems (HK) Ltd., this Authority accepts that the fitting described below complies with, and its use when correctly installed does not contravene, the Waterworks Ordinance and Regulations.

Name of Manufacturer: Delabie
Country of Origin: France
Brand: Delabie
Details of Fitting: 3/4" Self closing shower mixer
Model: 790970
Body Markings: **DELABIE**
Expiry Date: 21 January 2024



This Authority hereby permits the use of the above fitting in fresh water plumbing systems subject to full adherence to Waterworks installation requirements. In particular, you are required to draw your customers' attention to the following requirement-

"The cold water supply to the fitting shall be drawn from the same source that supplies the hot water apparatus so as to provide a balanced pressure and to obviate the risk of scalding in the event of a restriction or failure in the water supply." AND

"The shower head or handspray should not be placed in submerged conditions and should be securely fixed to the original position after use."

A condition of this acceptance is that the fitting to be installed shall be replicas of the sample as certified by the testing agent mentioned above and without modifications. This acceptance may be withdrawn at any time if the standard of the fitting installed fails to meet that of the approved sample or if the fitting is found to be unsuitable for use in fresh water plumbing systems.

This acceptance is only applicable to the main body of the fitting, unless otherwise specified.

For the use of the fitting in any project, the General Acceptance Number of this letter must be quoted as a means of identification of acceptance of the fitting by this Authority.

Should you have any enquiries, please contact our Engineer Mr. Terry KUNG at tel. no. 3583 4086.

Yours faithfully,



(CHAN Chung-kun)

for Director of Water Supplies

Encl.

c.c. WSD 3321/1/82] - without catalogue
ME/MC] - with soft copy only